



VALVOLA DI MASSIMA PRESSIONE AD AZIONE DIRETTA
A CARTUCCIA CON OTTURATORE DIFFERENZIALE

RELIEF VALVES, DIRECT ACTING, WITH DIFFERENTIAL AREA PISTON,
CARTRIDGE CONSTRUCTION

Tipo/Type:

VMPD/C 50

3

06.01

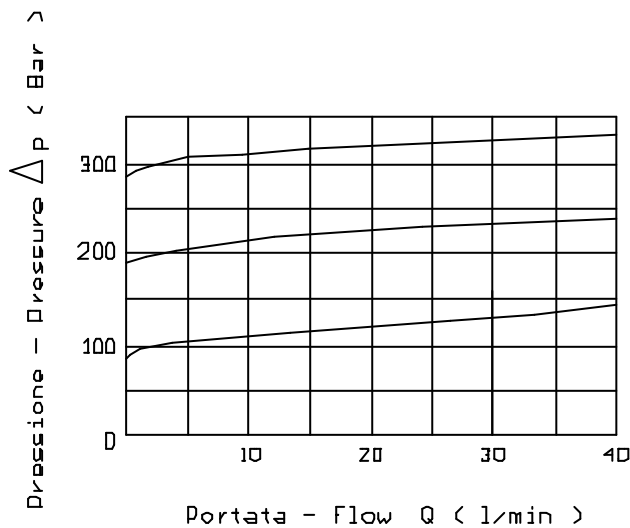
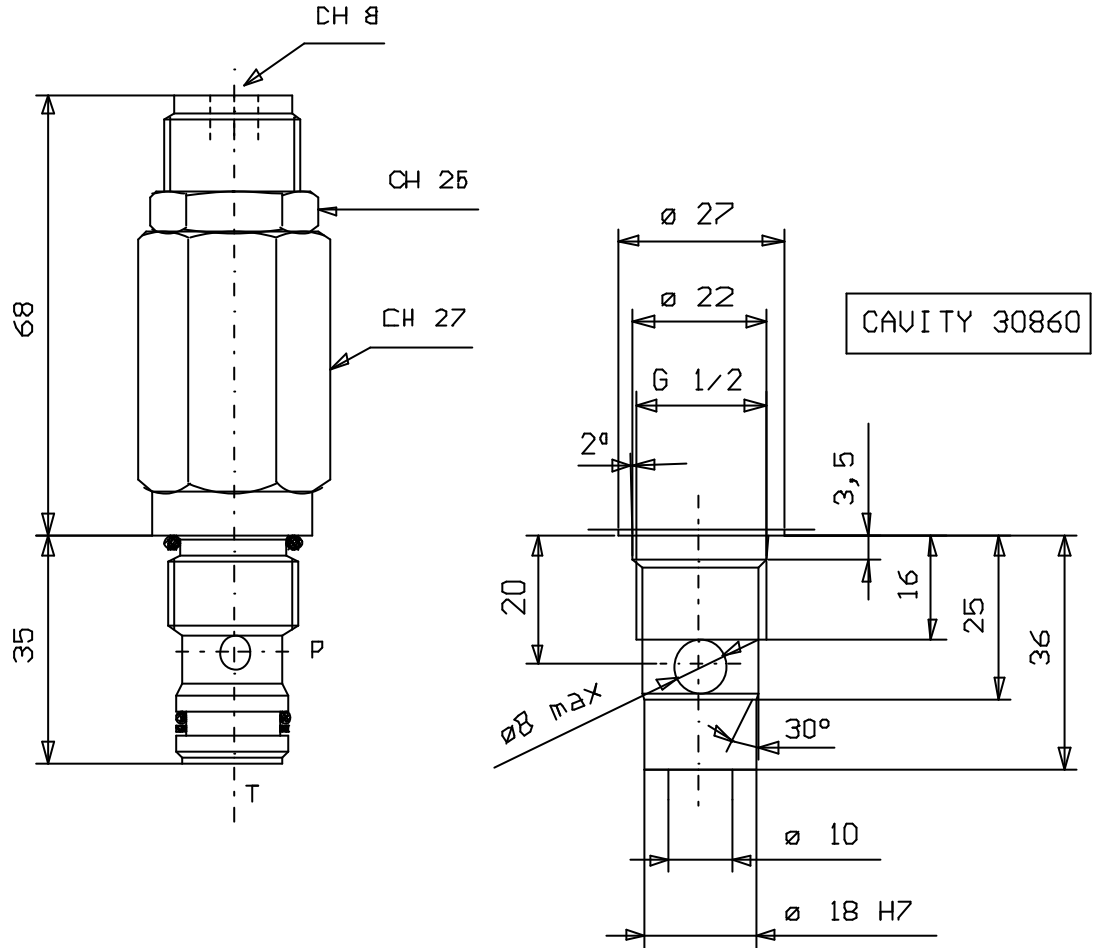

Coppia di serraggio
Installation torque

95 - 105 (Nm)

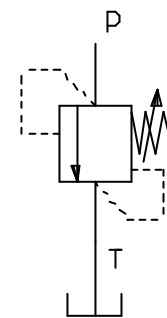

Press. max.
(Bar)

350

Portata max.
(l/min)

40